

# Maple Leaf WHEELCHAIR





## PARTS CATALOGUE Footrest



6540 Tomken Road  
Mississauga ON L5T 2E9  
905.564.2250  
905.564.5424  
1.800.362.0873  
[www.mapleleafwheelchair.ca](http://www.mapleleafwheelchair.ca)

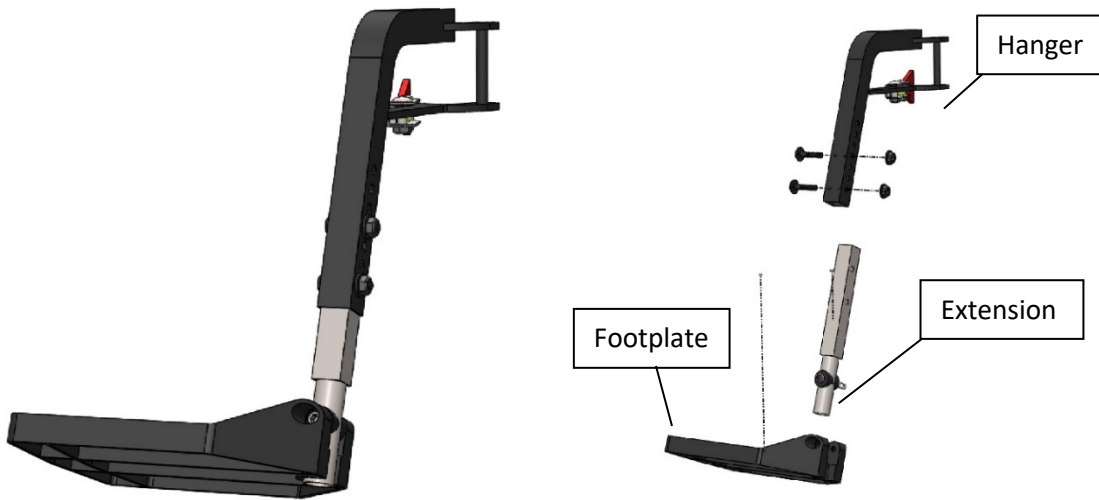

# Footrest





Part No.	Part Name	Part Description	Cost	
FR9001	Pin Style Footrest R (Plastic/Aluminum Footplate) [Standard 70 deg]	Right Side Pin Style Footrest Assembly with Plastic/Aluminum Footplate. (Chair Serial Number needs to be mentioned)	180/ each	
FR9002	Pin Style Footrest L (Plastic/Aluminum Footplate) [Standard 70 deg]	Left Side Pin Style Footrest Assembly with Plastic/Aluminum Footplate. (Chair Serial Number needs to be mentioned)		
FR9002 AAF	Pin Style Footrest R (Angle Adjustable Footplate) [Standard 70 deg]	Right Side Pin Style Footrest Assembly with Angle Adjustable Footplate. (Chair Serial Number needs to be mentioned)	220/ each	
FR9002 AAF	Pin Style Footrest L (Angle Adjustable Footplate) [Standard 70 deg]	Left Side Pin Style Footrest Assembly with Angle Adjustable Footplate. (Chair Serial Number needs to be mentioned)		

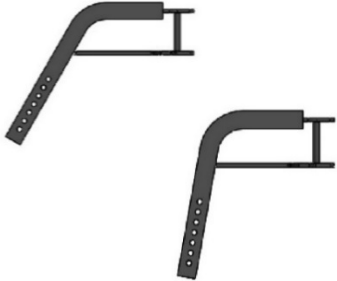

(All Images are for Visual reference please use the Part Description for determining the correct required part.)  
Maple Leaf Wheelchair ©2021





FR9032	Pin Style Footrest R with Custom Angled Hanger  (Plastic/Aluminum Footplate)	Right Side Pin Style Footrest Assembly with Plastic/ Aluminum Footplate and custom angled [60/80/90] hanger.  (Chair Serial Number needs to be mentioned)	190/ each	
FR9033	Pin Style Footrest L with Custom Angled Hanger  (Plastic/Aluminum Footplate)	Left Side Pin Style Footrest Assembly with Plastic/ Aluminum Footplate and custom angled [60/80/90] hanger.  (Chair Serial Number needs to be mentioned)		
FR9032 AAF	Pin Style Footrest R with Custom Angled Hanger  (Angle Adjustable Footplate)	Right Side Pin Style Footrest Assembly with Angle Adjustable Footplate and custom angled [60/80/90] hanger.  (Chair Serial Number needs to be mentioned)	230/ each	
FR9033 AAF	Pin Style Footrest L with Custom Angled Hanger  (Angle Adjustable Footplate)	Left Side Pin Style Footrest Assembly with Angle Adjustable Footplate and custom angled [60/80/90] hanger.  (Chair Serial Number needs to be mentioned)		

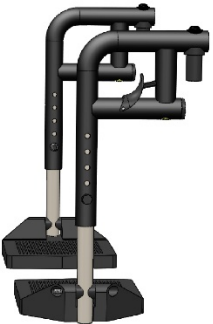

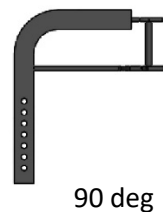
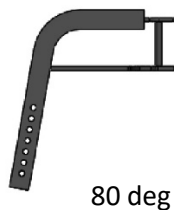
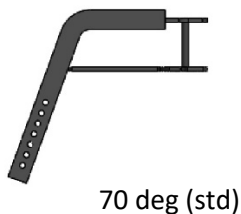
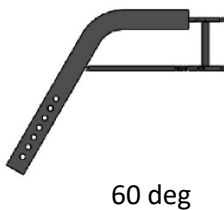
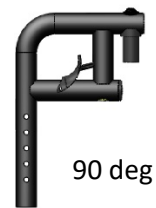

FR9045	Plug-In Style Footrest R  (Plastic/Aluminum Footplate) [Standard 70 deg]	Right Side Plug-In Style Footrest Assembly with Plastic/ Aluminum Footplate.  (Chair Serial Number needs to be mentioned)	190/ each	
FR9046	Plug-In Style Footrest L  (Plastic/Aluminum Footplate) [Standard 70 deg]	Left Side Plug-In Style Footrest Assembly with Plastic/ Aluminum Footplate.  (Chair Serial Number needs to be mentioned)		
FR9045 AAF	Plug-In Style Footrest R  (Angle Adjustable Footplate) [Standard 70 deg]	Right Side Plug-In Style Footrest Assembly with Angle Adjustable Footplate.  (Chair Serial Number needs to be mentioned)	230/ each	
FR9046 AAF	Plug-In Style Footrest L  (Angle Adjustable Footplate) [Standard 70 deg]	Left Side Plug-In Style Footrest Assembly with Angle Adjustable Footplate.  (Chair Serial Number needs to be mentioned)		



FR007R	<p>Plug-In Style Footrest R with Custom Angled Hanger</p> <p>(Plastic/Aluminum Footplate)</p>	<p>Right Side Plug-In Style Footrest Assembly with Plastic/ Aluminum Footplate and custom angled [60/80/90] hanger.</p> <p>(Chair Serial Number needs to be mentioned)</p>	200/ each	
FR007L	<p>Plug-In Style Footrest L with Custom Angled Hanger</p> <p>(Plastic/Aluminum Footplate)</p>	<p>Left Side Plug-In Style Footrest Assembly with Plastic/ Aluminum Footplate and custom angled [60/80/90] hanger.</p> <p>(Chair Serial Number needs to be mentioned)</p>		
FR008R	<p>Plug-In Style Footrest R with Custom Angled Hanger</p> <p>(Angle Adjustable Footplate)</p>	<p>Right Side Plug-In Style Footrest Assembly with Angle Adjustable Footplate and custom angled [60/80/90] hanger.</p> <p>(Chair Serial Number needs to be mentioned)</p>	240/ each	 
FR008L	<p>Plug-In Style Footrest L with Custom Angled Hanger</p> <p>(Angle Adjustable Footplate)</p>	<p>Left Side Plug-In Style Footrest Assembly with Angle Adjustable Footplate and custom angled [60/80/90] hanger.</p> <p>(Chair Serial Number needs to be mentioned)</p>		

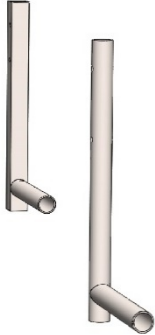
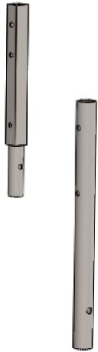

FR9003	Pin Style Footrest Hanger R	Right Side Pin Style Footrest Hanger.  (Chair Serial Number needs to be mentioned)	100/ each	
FR9004	Pin Style Footrest Hanger L	Left Side Pin Style Footrest Hanger.  (Chair Serial Number needs to be mentioned)		
FR102R	Pin Style Custom Angled Footrest Hanger R	Right Side Pin Style Custom Angled Footrest Hanger.  (Chair Serial Number needs to be mentioned)	110/ each	
FR102L	Pin Style Custom Angled Footrest Hanger L	Left Side Pin Style Custom Angled Footrest Hanger.  (Chair Serial Number needs to be mentioned)		
FR9038	Plug-in Style Footrest Hanger	Plug-in style Footrest Hanger.  (Chair Serial Number needs to be mentioned)	110/ each	
FR9047	Plug-in Style Custom Angled Footrest Hanger	Plug-in Style Custom Angled Footrest Hanger.  (Chair Serial Number needs to be mentioned)	120/ each	



FR9006	Pin style Footrest Extension  (For the Aluminum Footplate)	Pin-Style Footrest Extension for Aluminum Footplates.	70/ each	
FR9041	Plug-in style Footrest Extension  (For the Aluminum Footplate)	Plug-In Style Footrest Extension for Aluminum Footplates.		
FR9005	Pin style Footrest Extension  (For the Plastic & Angle Adjustable)	Pin Style Footrest Extension for Plastic and Angle Adjustable Footplate.	70/ each	
FR9040	Plug-in style Footrest Extension  (For the Plastic & Angle Adjustable)	Plug-In Style Footrest Extension for Plastic and Angle Adjustable Footplate.		
AAF	Angle Adjustable Pivot and Clamp	Angle adjustable footrest Pivot that connects to extension and Clamp that mounts the footplate.  Sold with B2H14 (Bolt) + HDW009 (Nut) + HDW061(Washer) + 2x B4FM6 (M6 Screw) + 2x N6L (M6 Nut)	40/ set	

(All Images are for Visual reference please use the Part Description for determining the correct required part.)  
Maple Leaf Wheelchair ©2021

FR009R	Pin Style Footrest R  (Stainless Steel) [Standard 70 deg]	Stainless-Steel Right-Side Pin Style Footrest Assembly for all commode wheelchair models.  (Chair Serial Number needs to be mentioned)	230/ each	
FR009L	Pin Style Footrest L  (Stainless Steel) [Standard 70 deg]	Stainless-Steel Left-Side Pin Style Footrest Assembly for all commode wheelchair models.  (Chair Serial Number needs to be mentioned)		
FR010R	Pin Style Footrest R with Custom Angled Hanger  (Stainless Steel) [60/80/90 deg]	Stainless- Steel Right-Side Pin Style Footrest Assembly having custom angled [60/80/90] hanger for all commode wheelchair models.  (Chair Serial Number needs to be mentioned)	240/ each	
FR010L	Pin Style Footrest L with Custom Angled Hanger  (Stainless Steel) [60/80/90 deg]	Stainless-Steel Left-Side Pin Style Footrest Assembly having custom angled [60/80/90] Hanger for all commode wheelchair models.  (Chair Serial Number needs to be mentioned)		

(All Images are for Visual reference please use the Part Description for determining the correct required part.)  
Maple Leaf Wheelchair © 2021

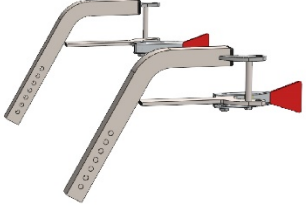
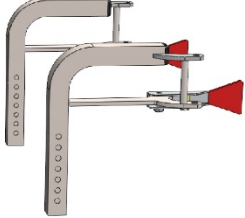

FR111R	Pin Style Footrest Hanger R  (Stainless Steel)	Stainless-Steel Right-Side Pin Style Footrest Hanger for all commode wheelchair models.  (Chair Serial Number needs to be mentioned)	120/ each	
FR111L	Pin Style Footrest Hanger L  (Stainless Steel)	Stainless-Steel Left-Side Pin Style Footrest Hanger for all commode wheelchair models.  (Chair Serial Number needs to be mentioned)		
FR112R	Pin Style Custom Angled Footrest Hanger R  (Stainless Steel) [60/80/90 deg]	Stainless-Steel Right-Side Pin Style Custom Angled Footrest Hanger for all commode wheelchair models.  (Chair Serial Number needs to be mentioned)	130/ each	
FR112L	Pin Style Custom Angled Footrest Hanger L  (Stainless Steel) [60/80/90 deg]	Stainless-Steel Left-Side Pin Style Custom Angled Footrest Hanger for all commode wheelchair models.  (Chair Serial Number needs to be mentioned)		
FR221	Pin style Footrest Extension  (Stainless Steel)	Stainless-Steel Pin Style Footrest Extension for all commode wheelchair models.	90/ each	



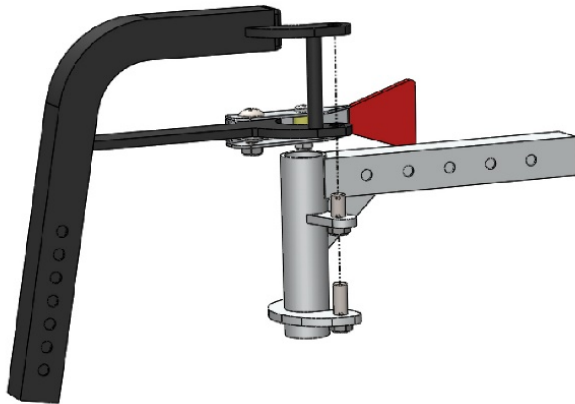

Pin Style

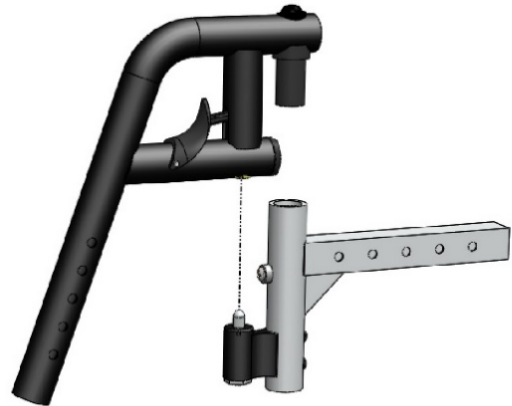

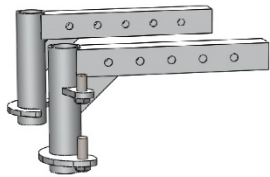
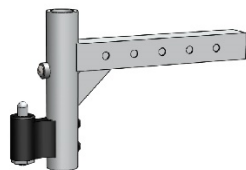
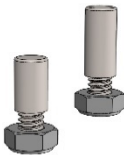

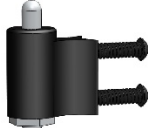

Plug-in Style



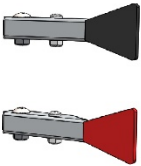

SFST713	Pin Style footrest Support Bracket R Super Tilt Low Rider	Right side Pin Style Support Bracket for Tilt Wheelchairs. Sold with [FR9067T]+ [FR9067B]	80/ each	
SFST713	Pin Style footrest Support Bracket L Super Tilt Low Rider	Left side Pin Style Support Bracket for Tilt Wheelchairs. Sold with [FR9067T] + [FR9067B]		
SFST713 PI	Plug-in Style Footrest Support Bracket Super Tilt Low Rider	Plug-in Style Support Bracket for the Super Tilt Wheelchair. Sold With Plug-In Block [FREG5] + Bearing [FSEG001]	130/ each	
FR9067T	Top pin set	Footrest Bracket Top Pin. (Shorter pin) Sold with Locking nut [HDW010]	3/ piece	
FR9067B	Bottom pin set	Footrest Bracket Top Pin. (Longer pin) Sold with Locking nut [HDW010]		



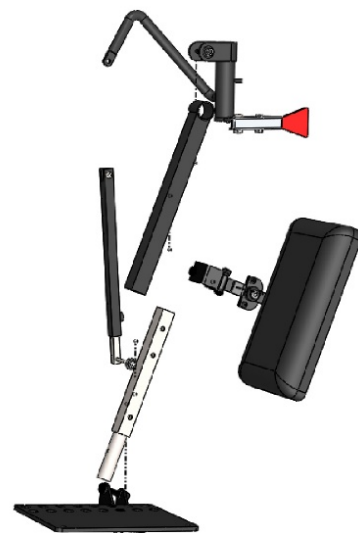

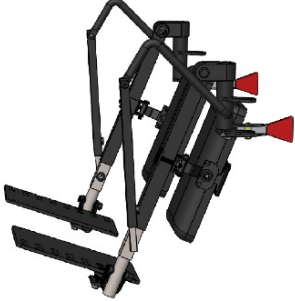
FREG5	Plug-in Release Pin block	<p>Plug-in style locking mechanism block that locks hanger.</p> <p>Block Sold with 2x [HDW033] (Screw) + 2x [HDW070] (Washer)</p>	40/ set	
FSEG001	Plug-in Vertical stop	<p>Swivel Bearing on top of mechanism that holds it in place.</p> <p>Bearing Sold with [HDW098]. (#10-32 x 1/2" Long Round Cap Phillips-Square Screw.) (UNF)</p>	10/ set	
EGBSH 001	Plug-in Footrest Pivot Bushing Vertical Set	<p>Plug-in style hanger mount bushing attaches hanger to frame for Super Tilt wheelchair.</p> <p>[BB008/ BB030] (Bushing) + [HDW033] (Screw) + [HDW070] (Washer)</p>	12/ set	
EGBSH 002	Plug-in Footrest Pivot Bushing Vertical Set	<p>Plug-in style hanger mount bushing attaches hanger to frame for NRG+ Gold Wheelchair.</p> <p>[BB008/ BB030] (Bushing) + [HDW033] (Screw) + [HDW070] (Washer)</p>		
HWF003	1" Standard Plug	<p>Plug for all Plug-In style Footrests.</p> <p>(Standard 1" tubing)</p>	1/ each	
HWF001	3/4" Standard Plug	<p>Plug for the footrest Extension.</p> <p>(Standard 3/4" tubing)</p>	1/ each	

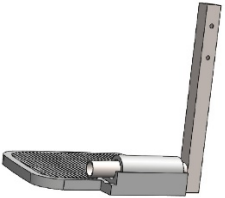
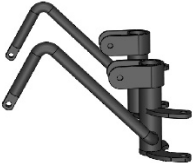

PPG036	Footrest Hanger Reducer Cap	Reducer Cap for the Footrest Hanger.  (Holds tubular footrest Extension in place).	5/ each	
PPG024	7/8"Footrest Plug  (Pin style)	Plug for all Pin style Footrests.  (Standard 7/8" Square tubing)	1/ each	
FR9007	Footrest Release Handle	Footrest release handle to activate Pin style mechanism.	10/ each	
FR9007SS	Footrest Release Handle (SS)	Stainless Steel Footrest release handle to activate Pin style mechanism.		
FR9008	Footrest Release Spring R	Right hand side footrest release spring.	4/ each	
FR9009	Footrest Release Spring L	Left hand side footrest release spring.		





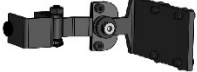

FR9019	Pin Style Articulating Footrest Assembly R  (Aluminum Footplate)	Right Side Pin Style Articulating Footrest with Aluminum Footplate.  (Chair Serial Number needs to be mentioned)	460/ each	
FR9020	Pin Style Articulating Footrest Assembly L  (Aluminum Footplate)	Left Side Pin Style Articulating Footrest with Aluminum Footplate.  (Chair Serial Number needs to be mentioned)		
FR9019 AAF	Pin Style Articulating Footrest Assembly R  (Angle Adjustable Footplate)	Right Side Pin Style Articulating Footrest with Angle Adjustable Footplate.  (Chair Serial Number needs to be mentioned)	480/ each	  
FR9020 AAF	Pin Style Articulating Footrest Assembly L  (Angle Adjustable Footplate)	Left Side Pin Style Articulating Footrest with Angle Adjustable Footplate.  (Chair Serial Number needs to be mentioned)		
FR9021	Articulating Bracket R	Right Side Bracket for the Articulating Footrest.	80/ each	
FR9022	Articulating Bracket L	Left Side Bracket for the Articulating Footrest.		

(All Images are for Visual reference please use the Part Description for determining the correct required part.)  
Maple Leaf Wheelchair ©2021

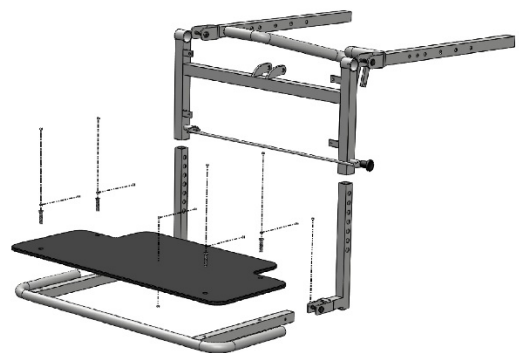
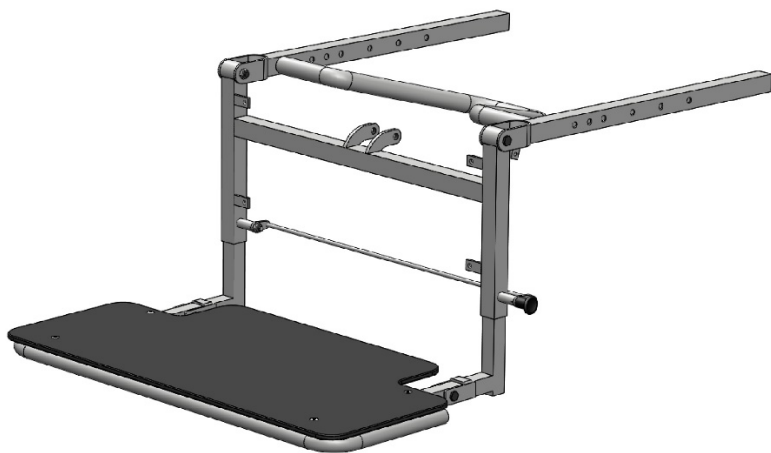
FR502	Articulating Upper link rod	Upper Link Rod connecting the Footrest Hanger to the Bracket.	30/ each	
FR503	Articulating Lower link rod	Lower Link Rod connecting the Footrest Hanger to the Bracket.	30/ each	
FR505R	Articulating Footrest Hanger R	Right Side Articulating Footrest Hanger.	40/ each	
FR505L	Articulating Footrest Hanger L	Left Side Articulating Footrest Hanger.		
FR504	Articulating link cover	Padded cover for the links.	30/ each	
FR506	Articulating Footrest Hanger cover	Padded Cover for the articulating footrest hanger.	40/ each	

FR507R	Articulating Footrest Calf Pad Brackets R	Right Side Brackets for mounting the Calf pad on the articulating footrest assembly.	80/ each	
FR507L	Articulating Footrest Calf Pad Brackets L	Left Side Brackets for mounting the Calf pad on the articulating footrest assembly.		
FR9065	Articulating Footrest Calf Pad	Calf pad for the Articulating footrest.	80/ each	
CC011	Faucher 200 N cylinder	200 N Faucher cylinder used in Articulating footrest.	200/ each	

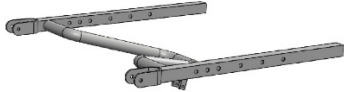
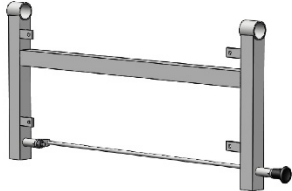





E3	<p>MLTR Footrest Complete Assembly</p> <p>Seat Width under 20"</p>	<p>Elevating system footrest complete assembly for the MLTR model.</p> <p>(Chair Serial Number needs to be mentioned)</p>	660/ each	
SHFML 814	MLTR frame bracket	<p>Elevating system bracket attaches hanger onto the frame for the MLTR model.</p> <p>Sold with required set of Nuts [B2H14] + Bolts [N2L]</p> <p>(Chair Serial Number needs to be mentioned)</p>	220/ each	
SHFML 812	MLTR Footrest Hanger	<p>Elevating system footrest hanger for the MLTR model.</p> <p>Sold with required set of Upholstery screws [HDW098]</p> <p>(Chair Serial Number needs to be mentioned)</p>	180/ each	
SHFML 813	MLTR Hanger Insert	<p>Elevating system footrest insert, goes into hanger, and holds footrest in place for the MLTR model.</p> <p>Sold with required set of Nuts [HDW006] + Bolts [B1H14]</p> <p>(Chair Serial Number needs to be mentioned)</p>	40/ each	

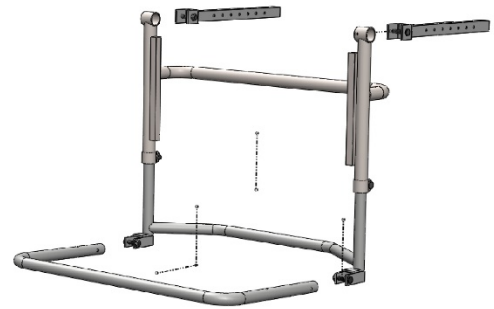
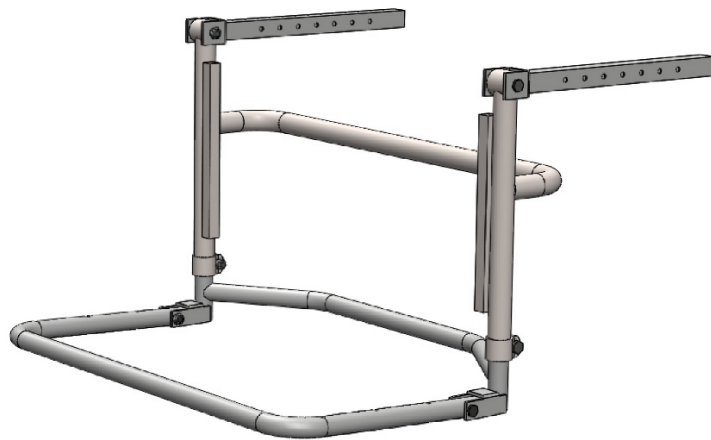

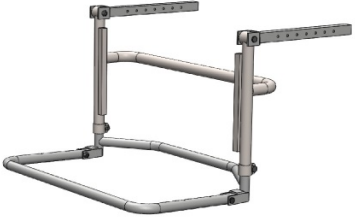

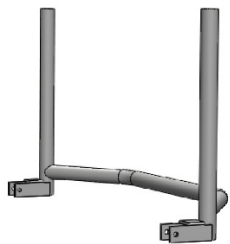

CC002	200 N cylinder Short.  MLTR	Short Suspa cylinder having a 200 N load used in the MLTR elevating footrest.	220/ each	
CABG001	Gas Cylinder Cable Single Head	Cable for the Suspa gas cylinder having a single head.	60/ each	
TRCH006	Cable Release Handle	Tilt and Recline release handle for all tilting and reclining wheelchairs.	30/ each	
SFML811	MLTR Footrest Frame	Elevating system folding footrest frame for the MLTR model.  (Chair Serial Number needs to be mentioned)	80/ each	
UPHML 329	MLTR Footboard	ABS Footrest for the MLTR model.  Sold with required, 4x M6 Nut [N6L] + 4x M6 Bolts [HDW047]  (Chair Serial Number needs to be mentioned)	40/ each	

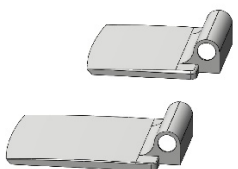

ES	MLT 700 Footrest Complete Assembly	Elevating system footrest complete assembly for the MLT 700 model.  (Chair Serial Number needs to be mentioned)	680/ each	
FR701	MLT 700 Hanger Bracket set	Elevating system hanger support attaches hanger onto the frame for the MLT 700 model.  Sold with required set of Nuts [B2H14] + Bolts [N2L]  (Chair Serial Number needs to be mentioned)	40/ each	

ESSUP	MLT 700 Footrest Hanger	Elevating system footrest hanger for the MLT 700 model.  Sold with required set of Nuts [HDW006] + Bolts [B1H14]  (Chair Serial Number needs to be mentioned)	160/ each	
ESAXT	MLT 700 Hanger Insert	Elevating system footrest insert, goes into hanger, and holds footrest in place for the MLT 700 model.  (Chair Serial Number needs to be mentioned)	160/ each	
ESFPT	MLT 700 Folding Footrest	Elevating system folding footrest for the MLT 700 model. Sold with required set of Nuts [B2H14] + Bolts [N2L]  (Chair Serial Number needs to be mentioned)	60/ each	
CC001	150 N cylinder Long.  MLT700	Long Suspa cylinder having a 150 N load used in the MLT700 elevating footrest.	220/ each	

CABG001	Gas Cylinder Cable Single Head	Cable for the Suspa gas cylinder having a single head.	60/ each	
FR901	Moulded Plastic Footplate small	Small-moulded plastic footplate set. 16"- 18" seat width	40/ each	
FR902	Moulded Plastic Footplate large	Large-moulded plastic footplate set. 20"+ seat width		
FR903	Aluminum Footplate small	Small non-angle adjustable aluminum footplate set. 16" seat width Sold with [FR906]	50/ each	
FR904	Aluminum Footplate large	Large non-angle adjustable aluminum footplate set. 18" seat width Sold with [FR906]		
FR9063	Extra Large Aluminum Footplate	Extra Large non-angle adjustable aluminum footplate. 20"+ seat width Sold with [FR906]	60/ each	
FR9062	Footrest clip	Footrest clip for the Aluminum Footplates of all sizes.	3/ each	

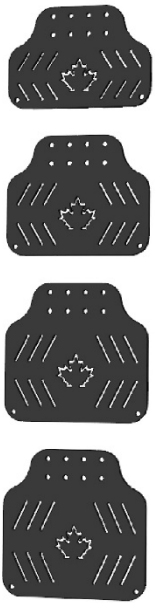
FR907	Angle Adjustable Footplate 16"	Footplate for the angle adjustable footrest for 16 in width.  (Chair serial number needs to be mentioned) Articulating system use custom footplate.	65/ each	
FR908	Angle Adjustable Footplate 18"	Footplate for the angle adjustable footrest for 18 in width.  (Chair serial number needs to be mentioned) Articulating system use custom footplate.		
FR909	Angle Adjustable Footplate 20"	Footplate for the angle adjustable footrest for 20 in width.  (Chair serial number needs to be mentioned) Articulating system use custom footplate.		
FR910	Angle Adjustable Footplate 22"	Footplate for the angle adjustable footrest for 22 in width.  (Chair serial number needs to be mentioned) Articulating system use custom footplate.		
ADD-AT	Articulating Mechanism Footplate	Angle Adjustable Footplate for the Articulating Footrest Mechanism.  (Custom Footplate for the Articulating Mechanism. ADD "AT" to the end of existing part numbers to order.)		
UPHA509	Heel Loop	Heel Loop for all the footplates.  Sold with [HDW101] + [HDW037] + [HDW009]	25/ Pair	